



GULF STATE HANGERS

AND

SUPPORTS MANUFACTURERS, INC.

Variable Spring Catalog

P.O. Box 407
Theodore, AL 36590
Phone: (251) 653-6228

7100 Bellingrath Road
Theodore, AL 36582
Fax: (251) 653-5356

E-mail: gshangers@aol.com

Website: www.gshangers.com

CATALOG 5/03

**Distributed by: Osland Piping Supply Ph: 651-552-9773 Fax: 651-450-4502
www.oslandpiping.com**

Gulf State Hangers is the official licensee in the United States for Pipe Supports Ltd.

Pipe Supports Limited was formed in 1968 to design and manufacture the Comet range of pipe hangers. Pipe Supports Ltd has an enviable reputation of quality, reliability, competitiveness, engineering excellence and financial strength. Our products have been supplied to every continent of the world through an international sales network dedicated to meeting its customers' stringent quality and delivery requirements.

From its origins in the heart of the United Kingdom, Pipe Supports Limited has grown into a worldwide organization with manufacturing plants in the UK, USA, India, Thailand, and Malaysia.

The Pipe Supports Group has a continual development program, resulting in the most comprehensive range of products available from one source. To ensure the products are of the highest standard, they are produced in manufacturing plants equipped with the latest technology.

Through the global manufacturing presence, we are able to offer competitive prices for projects around the world.

Engineered Products:

Constant Effort Supports

Variable Effort Supports

Dynamic Restraints

Easy-Slide Bearings

Cryogenic Supports

VARIABLE SUPPORTS

STANDARD FEATURES

1. Compactness of units. Installed heights designed to a minimum.
2. Preset and multi-locking device allowing the unit to be supplied locked at its installed load and ready to accept a test load of at least twice the rated load. The infinitely adjustable multi-lock is permanently fixed to the unit, allowing relocking at any travel position. This is of particular benefit at times of plant outages or during pipe work maintenance/ inspection.
3. Over travel is provided on either side of the working range.
4. Supports are fitted with nameplates marked with the installed and operating load, support reference mark, type and a unique serial number.
5. **Standard Inventory Finish:** Hot Dipped Galvanized
6. Coils come with a protective coating.

Advantages of a Protective Coating:

- Protects from a wide range of corrosives.
- Does not affect the flex life of the spring.

OPTIONAL FEATURES

1. Limit Stops. The preset / multi-lock facility may be enhanced to precisely limit spring travel. Additional nuts welded in position are used to limit movement to a specified amount.
2. For extended life in offshore or other situations subject to highly corrosive conditions, supports are available in various grades of stainless steel. Spring coils are available in 17.4 PH precipitation hardened stainless steel. Please check with our design department for dimensional information.
3. For type F supports, where horizontal movement of more than $\frac{1}{2}$ " is envisaged, teflon covered load pads or double pipe rollers should be specified.

VARIABLE SUPPORTS

TYPE

Determine the type of unit required, i.e. A, B, C, D, E, F or G. Selection of type will depend upon the location of the steelwork/concrete and available space.

Once the travel range, spring size and type have been selected, the description can be written, e.g. **VS-18-C** or **VM-XX-F**.

DETERMINING INSTALLED DIMENSIONS

Detailed dimensions of 'Comet' Variable Spring Supports can be read directly from the tabulated dimensions. For Types A, B, C, and G the RTO or rod take out dimension is given at zero spring deflection. At greater spring compression, the rod will penetrate further into the turnbuckle. For Types D and E, dimension 'J' is given at zero spring deflection. At greater spring compression the rod will extend further above the spring plate.

For type F, the installed height can be adjusted independently of spring compression.

For supports with cold to hot pipe movement up, installed height 'J' should be half way between the minimum and maximum 'J' dimension.

For supports with cold to hot pipe movement down, installed height 'J' should be half way between the minimum and maximum 'J' dimension plus the amount of vertical movement.

Determining installed dimensions is in line with normal USA practice.

ORDERING

When ordering, advise either:

- A) I) Quantity.
- II) Support Description, i.e.

VM	12	C
<i>Travel Range</i>	<i>Spring Size</i>	<i>Type</i>
- III) Operating Load
- IV) Installed to operating movement and direction.
- V) Finish required.
- VI) Support Mark No.

If the exact load and movement are not known, springs will be supplied set at mid-travel.

- Or B) I) Quantity.
- II) Support Type
- III) Operating Load
- IV) Installed to operating movement.
- V) Allowable variation. This will be taken as 25% of the operating load unless otherwise stated.
- VI) Finish required.
- VII) Support Mark No.

In this case, we will determine the support size to be supplied.

INSTALLATION AND ERECTION

Types A, B, C, D and E

Lift the support carefully into position and secure to the hanger rod for type A, to the beam attachment for types B and C or to the support beams for types D and E. Make the connection to the pipe work via the hanger rod and pipe clamp. Apply tension to the spring unit by rotating the turnbuckle (or adjusting nut for type D). When the preset load is attained, the locking nuts above the spring plate will become free to rotate. The locking nuts below the spring plate are then ready to carry any hydrostatic test load. On completion of hydrostatic testing, lagging etc., the locking nuts must be fully backed off from the spring plate to the unlocked position.

Type F

For Type F supports, the load is transferred to the support by rotation of the load adjustment nut, which is situated below the load pad, rather than via a turnbuckle. Then proceed as for Type A etc.

Type G

The procedure is similar to Type A etc. except that the spring housings are inverted, and application of the load will release the locking nuts below the spring plates, with the nuts above the spring plates carrying the hydrostatic test load.

MAINTENANCE

'Comet' Variable Spring Supports are designed to be maintenance free. On no account should any attempt be made to remove the spring coil from the housing, since it has been pre-compressed. Periodic inspection should be carried out at a frequency that suits the environment in which they are used. Check for visual damage, for any corrosion (especially of the spring coil and threaded rods) and to ensure that no debris has fallen into the support which could impede the movement of the spring.

PICTORIAL INDEX

VARIABLE SPRINGS

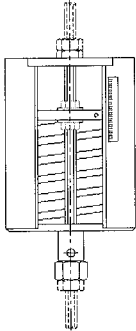

TYPE A

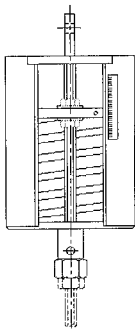

TYPE B

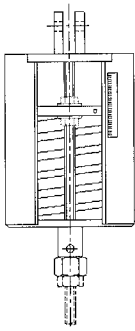

TYPE C

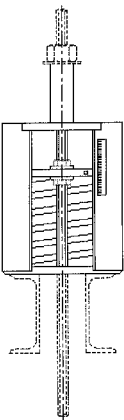

TYPE D

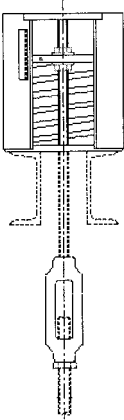

TYPE E

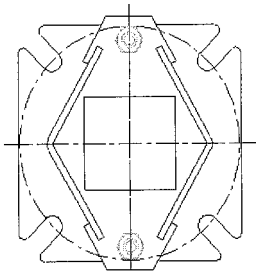
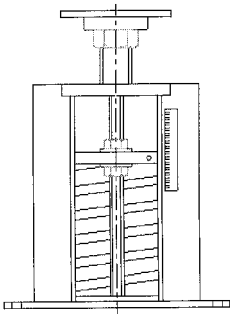

TYPE F

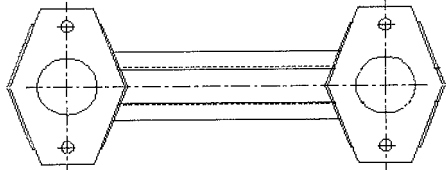
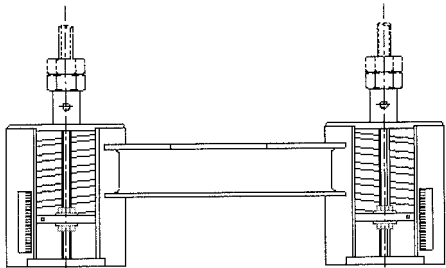

TYPE G

VARIABLE SUPPORTS

APPLICATION

Variable Spring Supports are used to support the weight of pipe work or equipment while allowing a degree of movement relative to the supporting structure. Where pipes transport hot (or cold) liquids or gases, they expand (or contract) due to the difference between operating and ambient temperatures. It is necessary to support the pipe in the operating and ambient conditions, while permitting movement between the two. Variable effort supports may also be needed to cater for ambient temperature variation local to items of plant or long vertical pipe runs, or where pipes pass between buildings that may be subject to relative movement due to subsidence or earthquake.

RANGE

GULF STATE HANGERS manufactures a wide range of Variable Spring Supports catering for loads from 12 to 50,000 pounds.

Available in the following variations:

WORKING RANGES

SHORT SPRING	VS	1 1/4"
STANDARD SPRING	VM	2 1/2"
LONG SPRING	VL	5"

With 26 spring sizes (XXX to 22) within each travel range.

SUPPORT TYPES

A, B, C	Top Suspended
D	Top Adjustable
E	Extended Support
F	Base Mounted Support
G	Trapeze Assembly

RELATED SPECIFICATIONS

'Comet' Variable Spring Supports are designed and manufactured to meet the requirements of the following specifications:

ASME B31.1 MSS SP-69 MSS SP-58

ASME B31.3 MSS SP-89

SELECTION OF VARIABLE SPRING SUPPORTS

Selection of the size and range of spring support is by means of the selection charts provided.

Range: The choice of range VS, VM or VL will depend upon the pipe movement at the support position and the allowable change in effort.

$$\text{Change in Effort} = \text{Movement} \times \text{Spring Rate}$$

This is often expressed as a percentage of operating load.

$$\text{Variation in Effort} = \frac{\text{Movement} \times \text{Spring Rate}}{\text{Operating Load}} \times 100\%$$

This variation is usually limited to 25% although greater variation is sometimes specified where a higher spring rate is justified in the pipe work analysis, or lesser where supporting critical items.

For guidance on selecting the travel range, movements of 5/8", 1 1/4" and 2 1/2" will produce variation in effort of approximately 25% of a 'mid-table' load on ranges VS, VM and VL respectively.

SELECTION PROCEDURE

1. Determine the required supporting effort and pipe movement (up or down) installed to operating. Weights of spreader beams, heavy pipe clamps etc. should be added to the pipe load.
2. Estimate which travel range will be required (See above).
3. Select the smallest spring size that has the operating load within the working range.
4. Ensure that the selected spring can accommodate the preset to operating travel within the working range. This is done by moving up or down the chart from the operating load by the amount of travel. Down if the movement 'installed to operating' is up, and up if the movement 'installed to operating' is down.
5. If the spring selected cannot accommodate the movement, try a larger spring size or the next travel range. If the movement cannot be accommodated by range VL, then a constant effort support is required.
6. Check the variation in supporting effort for the selected spring:

$$\text{Variation} = \frac{\text{Movement} \times \text{Spring Rate}}{\text{Operating Load}} \times 100\%$$

If this exceeds the allowable variation, then choose the next travel range and go back to 3 above. If the variation is less than half of the allowable, then a smaller travel range may be acceptable. Choose a smaller travel range and go back to step 4. If the variation exceeds the allowable for a VL selection then a constant effort support is required.

VARIABLE SUPPORTS - SELECTION CHART

Working Range, in			Hanger Size																								Spring Deflection, in					
Fig. VL	Fig. VM	Fig. VS	XXX	XX	X	0	1	2	3	4	5	6	7	8	9	10	11	12	13	14	15	16	17	18	19	20	21	22	VS	VM	VL	
			12	19	29	40	65	78	102	137	180	252	324	442	574	785	1008	1332	1776	2376	3192	4491	5998	7858	10551	13966	18152	24953	0	0	0	
			13	19	30	42	67	82	107	143	189	263	339	461	600	817	1051	1389	1852	2477	3329	4679	6248	8196	10996	14559	18958	25997				
			13	20	31	44	70	85	111	149	197	273	353	480	626	849	1094	1446	1928	2578	3466	4866	6498	8534	11441	15153	19765	27041				
			14	21	32	46	72	89	116	155	205	284	368	499	652	882	1137	1503	2004	2679	3603	5054	6748	8872	11886	15746	20571	28085				
W O R K I N G R A N G E	0	0	14	22	33	48	75	92	120	161	213	294	382	518	678	914	1180	1560	2080	2780	3740	5242	6998	9210	12331	16339	21377	29129	1/4	1/2	1	
			15	22	35	50	77	96	125	167	222	305	397	537	704	946	1223	1617	2156	2881	3877	5430	7248	9548	12775	16932	22183	30173				
			15	23	36	52	80	99	129	173	230	315	411	556	730	979	1266	1674	2232	2982	4014	5618	7498	9886	13220	17525	22989	31217				
			16	24	37	54	82	103	134	179	238	326	426	575	756	1011	1309	1731	2308	3083	4151	5806	7749	10224	13665	18118	23795	32261				
	1	1/2	1/4	16	25	38	56	85	106	138	186	246	336	440	594	782	1043	1352	1788	2384	3184	4288	5994	7999	10562	14110	18711	24602	33305	1/2	1	2
				17	26	39	58	88	110	143	192	255	347	455	614	809	1076	1395	1845	2460	3285	4425	6182	8249	10900	14555	19304	25408	34349			
				17	26	41	60	90	113	147	198	263	357	469	633	835	1108	1438	1902	2536	3386	4562	6370	8499	11238	15000	19897	26214	35393			
				18	27	42	62	93	117	152	204	271	368	484	652	861	1140	1481	1959	2612	3487	4699	6557	8749	11576	15445	20490	27020	36437			
	2	1	1/2	18	28	43	64	95	120	156	210	279	378	498	671	887	1172	1524	2016	2688	3588	4836	6745	8999	11914	15890	21083	27826	37482	3/4	1 1/2	3
				19	29	44	66	98	124	161	216	287	389	513	690	913	1205	1567	2073	2764	3689	4973	6933	9249	12252	16335	21676	28632	38526			
				19	29	45	68	100	127	165	222	296	399	527	709	939	1237	1610	2130	2840	3790	5110	7121	9499	12590	16780	22269	29438	39570			
				20	30	46	70	103	131	170	228	304	410	542	728	965	1269	1653	2187	2916	3891	5247	7309	9749	12928	17225	22862	30245	40614			
	3	1 1/2	3/4	20	31	48	72	106	134	174	234	312	420	556	747	991	1302	1696	2244	2992	3992	5384	7497	9999	13266	17670	23455	31051	41658	1	2	4
				21	32	49	74	108	138	179	240	320	431	571	766	1017	1334	1739	2301	3068	4093	5521	7685	10249	13604	18115	24049	31857	42702			
				21	33	50	76	111	141	183	246	329	441	585	785	1043	1366	1782	2358	3144	4194	5658	7873	10499	13942	18560	24642	32663	43746			
				22	33	51	78	113	145	188	252	337	452	600	805	1070	1399	1825	2415	3220	4295	5795	8061	10750	14280	19005	25235	33469	44790			
	4	2	1	22	34	52	80	116	148	192	258	345	462	614	824	1096	1431	1868	2472	3296	4396	5932	8248	11000	14618	19450	25828	34275	45834	1 1/4	2 1/2	5
				23	35	54	82	118	152	197	264	353	473	629	843	1122	1463	1911	2529	3372	4497	6069	8436	11250	14956	19895	26421	35082	46878			
				23	36	55	84	121	155	201	270	362	483	643	862	1148	1495	1954	2586	3448	4598	6206	8624	11500	15294	20340	27014	35888	47922			
				24	36	56	86	123	159	206	276	370	494	658	881	1174	1528	1997	2643	3524	4699	6343	8812	11750	15632	20785	27607	36694	48966			
5	2 1/2	1 1/4	24	37	57	88	126	162	210	282	378	504	672	900	1200	1560	2040	2700	3600	4800	6480	9000	12000	15970	21230	28200	37500	50010	1 1/2	3	6	
			25	38	58	90	129	165	214	288	386	514	686	919	1226	1592	2083	2757	3676	4901	6617	9188	12250	16308	21675	28793	38306	51054				
			25	39	60	92	131	169	219	294	394	525	701	938	1252	1625	2126	2814	3752	5002	6754	9376	12500	16646	22120	29386	39112	52098				
			26	40	61	94	134	172	223	300	403	535	715	957	1278	1657	2169	2871	3828	5103	6891	9564	12750	16984	22565	29979	39918	53142				
			26	40	62	96	136	176	228	306	411	546	730	976	1304	1689	2212	2928	3904	5204	7028	9752	13000	17322	23010	30572	40725	54186	1 3/4	3 1/2	7	
			Spring Rate - lb. Per in																													
VS			8	12	19	32	41	56	72	96	132	168	232	306	418	517	688	912	1216	1616	2192	3006	4001	5408	7120	9489	12898	16705	VS			
VM			4	6	10	16	21	28	36	48	66	84	116	153	209	258	344	456	608	808	1096	1503	2001	2704	3560	4745	6449	8352	VM			
VL			2	3	5	8	10	14	18	24	33	42	58	76	104	129	172	228	304	404	548	752	1000	1352	1780	2372	3225	4176	VL			

ALL TYPES						SUSPENDED TYPES											VARIABLE SUPPORTS - RANGE VS							
ALL TYPES						SUSPENDED TYPES											TYPE D							
Size	Rod Dia.	Body Dimensions				RTO			Min Thread Engagement AA	Depth of Thread A	AB (Min.)	AB (Max.)	Lug Dimensions Types B & C					Approx. Weights			Height J (at Zero Spring Def'n)	Allowance for Nuts AC	Approx. Weight	
		D	K	M	Casing Length L (not Type F)	TYPE A	TYPE B	TYPE C					E	F	G	H	T	TYPE A	TYPE B	TYPE C				
	in	in	in	in	in	in	in	in	in	in	in	in	in	in	in	in	in	in	lbs	lbs	lbs	in	in	lbs
VS-XXX	1/2	4 1/4	4 3/4	6 1/8	5 1/4	4 1/8	6	6	1 1/8	3/8	3/8	2 1/8	7/8	1 1/4	1 1/2	11/16	1/4	9	9	9	6 3/4	1 1/4	7	
VS-XX	1/2	4 1/4	4 3/4	6 1/8	5 1/4	4 1/8	6	6	1 1/8	3/8	3/8	2 1/8	7/8	1 1/4	1 1/2	11/16	1/4	9	9	9	6 3/4	1 1/4	7	
VS-X	1/2	4 1/4	4 3/4	6 1/8	5 1/4	4 1/8	6	6	1 1/8	3/8	3/8	2 1/8	7/8	1 1/4	1 1/2	11/16	1/4	9	9	9	6 3/4	1 1/4	7	
VS-0	1/2	4 1/4	4 3/4	6 1/8	5 1/4	4 1/8	6	6	1 1/8	3/8	3/8	2 1/8	7/8	1 1/4	1 1/2	11/16	1/4	9	9	9	6 3/4	1 1/4	7	
VS-1	1/2	4 1/4	4 3/4	6 1/8	5 1/2	4 1/4	6 1/8	6 1/8	1 1/8	3/8	1/4	2	7/8	1 1/4	1 1/2	11/16	1/4	9	9	10	7	1 1/4	8	
VS-2	1/2	4 1/4	4 3/4	6 1/8	5 5/8	4 7/8	6 3/4	6 3/4	1 1/8	3/8	3/4	2 1/2	7/8	1 1/4	1 1/2	11/16	1/4	9	9	10	7 1/8	1 1/4	8	
VS-3	1/2	4 1/4	4 3/4	6 1/8	5 9/16	4 5/16	6 3/16	6 3/16	1 1/8	3/8	1/4	2	7/8	1 1/4	1 1/2	11/16	1/4	9	10	10	7 1/16	1 1/4	8	
VS-4	1/2	4 1/4	4 3/4	6 1/8	5 11/16	4 7/8	6 3/4	6 3/4	1 1/8	3/8	11/16	2 7/16	7/8	1 1/4	1 1/2	11/16	1/4	10	10	10	7 3/16	1 1/4	8	
VS-5	1/2	4 1/4	4 3/4	6 1/8	5 13/16	4 7/8	6 3/4	6 3/4	1 1/8	3/8	9/16	2 5/16	7/8	1 1/4	1 1/2	11/16	1/4	10	10	10	7 5/16	1 1/4	8	
VS-6	5/8	4 1/4	4 3/4	6 1/8	6 5/8	5 3/16	7 3/16	7 3/16	1 1/4	1/2	5/16	2 1/16	1 1/16	1 1/4	1 1/2	13/16	1/4	10	11	11	8 1/8	1 1/2	9	
VS-7	5/8	4 1/4	4 3/4	6 1/8	7 1/8	6 1/16	8 1/16	8 1/16	1 1/4	1/2	11/16	2 7/16	1 1/16	1 1/4	1 1/2	13/16	1/4	11	12	12	8 5/8	1 1/2	10	
VS-8	5/8	4 1/4	4 3/4	6 1/8	8 1/16	6 5/8	8 5/8	8 5/8	1 1/4	1/2	5/16	2 1/16	1 1/16	1 1/4	1 1/2	13/16	1/4	13	13	13	9 9/16	1 1/2	11	
VS-9	3/4	5 3/4	6 1/2	7 7/8	8 5/8	7	9 1/8	9 1/8	1 3/8	5/8	3/8	2 1/8	1 1/4	1 1/4	1 1/2	15/16	3/8	26	26	27	10 1/8	1 3/4	23	
VS-10	3/4	5 3/4	6 1/2	7 7/8	7 5/8	7 1/2	9 5/8	9 5/8	1 3/8	5/8	1 7/8	3 5/8	1 1/4	1 1/4	1 1/2	15/16	3/8	24	25	26	9 1/8	1 3/4	21	
VS-11	3/4	5 3/4	6 1/2	7 7/8	8 3/16	6 9/16	8 11/16	8 11/16	1 3/8	5/8	3/8	2 1/8	1 1/4	1 1/4	1 1/2	15/16	3/8	26	26	27	9 11/16	1 3/4	23	
VS-12	1	6 7/8	7 3/4	9 7/8	9 1/16	7 9/32	9 15/16	9 15/16	1 5/8	1	1/2	2 1/4	1 5/8	1 1/2	2	1 1/4	1/2	44	45	46	10 9/16	2 1/4	37	
VS-13	1	6 7/8	7 3/4	9 7/8	9 3/4	7 31/32	10 5/8	10 5/8	1 5/8	1	1/2	2 1/4	1 5/8	1 1/2	2	1 1/4	1/2	48	50	53	11 1/4	2 1/4	40	
VS-14	1 1/4	6 7/8	7 3/4	9 7/8	10 11/16	8 25/32	12 7/16	12 7/16	1 7/8	1 1/4	5/8	2 3/8	2	2	3	1 1/2	5/8	55	58	62	12 3/16	3	45	
VS-15	1 1/4	8 3/4	9 7/8	13	11 7/16	9 9/32	13 3/16	13 3/16	1 7/8	1 1/4	5/8	2 3/8	2	2	3	1 1/2	5/8	95	98	101	12 15/16	3	79	
VS-16	1 1/2	8 3/4	9 7/8	13	13	10 15/32	14 5/8	14 5/8	2 1/8	1 1/2	3/4	2 1/2	2 3/8	2 1/2	3	1 3/4	3/4	120	124	129	14 1/2	3 1/2	98	
VS-17	1 3/4	8 3/4	9 7/8	13	14 1/2	11 1/2	16	16	2 3/8	1 3/4	7/8	2 5/8	2 5/8	2 1/2	3	2	3/4	151	158	167	16	4	122	
VS-18	2	13 1/8	14 3/4	19 5/8	14 3/4	11 7/8	17 1/8	17 1/8	2 5/8	2	1	2 3/4	2 7/8	3	4	2 3/8	3/4	287	297	310	16 1/4	4 9/16	247	
VS-19	2 1/4	13 1/8	14 3/4	19 5/8	15 3/4	12 3/4	18 1/2	18 1/2	2 13/16	2 3/16	1 1/16	2 13/16	3 1/8	3	4 1/2	2 5/8	3/4	337	350	367	17 1/4	5	291	
VS-20	2 1/2	13 1/8	14 3/4	20 1/2	17 1/16	14 3/8	20 3/8	20 3/8	3 1/16	2 7/16	1 7/8	3 5/8	3 3/8	4	4 1/2	2 7/8	1	385	406	429	18 9/16	5 9/16	326	
VS-21	2 3/4	13 1/8	14 3/4	20 7/8	19 1/2	16	22	22	3 5/16	2 11/16	1 5/16	3 1/16	3 5/8	4	4 1/2	3 1/8	1	488	505	530	21	6 1/4	408	
VS-22	3	13 1/8	14 3/4	21 1/4	22 1/2	18 5/8	25 3/8	25 3/8	3 9/16	2 15/16	1 7/16	3 3/16	3 7/8	4	5	3 3/8	1	614	637	666	24	6 5/8	503	

TYPE E			TYPE F														TYPE G							
Size	Height J (at Zero Spring Def'n)	Approx. Weight	Minimum Height J	Maximum Height J	Casing Length L	Bottom Flange Square S	Bottom Flange Bolt Circle P (min.)	Bottom Flange Bolt Circle P (max.)	Bottom Flange Bolt Centers Square U (min.)	Bottom Flange Bolt Centers Square U (max.)	Bottom Flange Bolt Size	Bottom Flange Thick V	Load Column Thread Size	Load Flange Square Y	Load Flange Thick Z	Approx. Weight	RTO	Minimum Thread Engagement AA	AD	Channel Size	Gap Between Channels W	Maximum Rod Centers C-C	Approx. Weight (at Max. Rod Centers)	
	in	lbs	in	in	in	in	in	in	in	in	in	in	in	in	in	in	lbs	in	in	in		in	in	lbs
VS-XXX	3 3/4	8	5 15/16	6 11/16	4 3/4	7 1/2	7	8 3/4	4 15/16	6 3/16	5/8	1/4	3/4	3	3/16	8	1/2	1 1/8	1 1/4	C3 x 4.1	5/8	24	32	
VS-XX	3 3/4	8	5 15/16	6 11/16	4 3/4	7 1/2	7	8 3/4	4 15/16	6 3/16	5/8	1/4	3/4	3	3/16	8	1/2	1 1/8	1 1/4	C3 x 4.1	5/8	24	32	
VS-X	3 3/4	8	5 15/16	6 11/16	4 3/4	7 1/2	7	8 3/4	4 15/16	6 3/16	5/8	1/4	3/4	3	3/16	8	1/2	1 1/8	1 1/4	C3 x 4.1	5/8	24	32	
VS-0	3 3/4	8	5 15/16	6 11/16	4 3/4	7 1/2	7	8 3/4	4 15/16	6 3/16	5/8	1/4	3/4	3	3/16	8	1/2	1 1/8	1 1/4	C3 x 4.1	5/8	24	32	
VS-1	4	8	5 15/16	6 11/16	5	7 1/2	7	8 3/4	4 15/16	6 3/16	5/8	1/4	3/4	3	3/16	8	3/8	1 1/8	1 1/4	C3 x 4.1	5/8	24	32	
VS-2	4 1/8	8	6 9/16	7 5/16	5 1/8	7 1/2	7	8 3/4	4 15/16	6 3/16	5/8	1/4	3/4	3	3/16	8	7/8	1 1/8	1 1/4	C3 x 4.1	5/8	24	32	
VS-3	4 1/16	8	6 1/2	7 1/4	5 3/16	7 1/2	7 3/4	8 3/4	5 1/2	6 3/16	3/4	3/8	1	3	3/16	12	3/8	1 1/8	1 1/4	C3 x 4.1	3/4	30	36	
VS-4	4 3/16	8	6 1/2	7 1/4	5 5/16	7 1/2	7 3/4	8 3/4	5 1/2	6 3/16	3/4	3/8	1	3	3/16	12	13/16	1 1/8	1 1/4	C3 x 4.1	3/4	30	37	
VS-5	4 5/16	9	6 5/8	7 3/8	5 7/16	7 1/2	7 3/4	8 3/4	5 1/2	6 3/16	3/4	3/8	1	3	3/16	12	11/16	1 1/8	1 1/4	C3 x 4.1	3/4	30	37	
VS-6	5	9	7 1/8	8 1/8	6 1/8	9	8	10 7/8	5 11/16	7 11/16	3/4	3/8	1 1/4	3	1/4	15	5/16	1 1/4	1 1/4	C3 x 4.1	1	36	43	
VS-7	5 1/2	10	8	9	6 5/8	9	8	10 7/8	5 11/16	7 11/16	3/4	3/8	1 1/4	3	1/4	16	11/16	1 1/4	1 1/4	C3 x 4.1	1	36	44	
VS-8	6 3/8	11	8 9/16	9 9/16	7 9/16	9	8	10 7/8	5 11/16	7 11/16	3/4	3/8	1 1/4	3	1/4	17	5/16	1 1/4	1 1/4	C3 x 4.1	1	36	47	
VS-9	6 11/16	23	9 3/16	10 3/16	8 1/16	13 1/4	10 9/16	16 1/2	7 1/2	11 11/16	3/4	3/8	1 1/2	4	1/2	33	1/4	1 3/8	1 1/4	C4 x 5.4	1 1/4	36	79	
VS-10	5 11/16	21	9 9/16	10 9/16	7 1/16	13 1/4	10 9/16	16 1/2	7 1/2	11 11/16	3/4	3/8	1 1/2	4	1/2	32	1 3/4	1 3/8	1 1/4	C4 x 5.4	1 1/4	36	75	
VS-11	6 3/16	22	8 3/4	9 3/4	7 5/8	13 1/4	10 9/16	16 1/2	7 1/2	11 11/16	3/4	3/8	1 1/2	4	1/2	34	1/4	1 3/8	1 1/4	C4 x 5.4	1 1/4	36	78	
VS-12	6 9/16	36	9 1/2	10 1/2	8 1/8	13 1/4	10 9/16	16 1/2	7 1/2	11 11/16	3/4	1/2	1 3/4	5	1/2	50	1/8	1 5/8	1 1/4	C5 x 6.7	1 1/2	36	120	
VS-13	7 1/4	40	10 3/16	11 3/16	8 13/16	13 1/4	10 9/16	16 1/2	7 1/2	11 11/16	3/4	1/2	1 3/4	5	1/2	52	1/8	1 5/8	1 1/4	C5 x 6.7	1 1/2	36	129	
VS-14	8 1/8	46	11 1/8	12 1/8	9 3/4	13 1/4	10 9/16	16 1/2	7 1/2	11 11/16	3/4	1/2	1 3/4	5	1/2	56	0	1 7/8	1 1/4	C5 x 6.7	1 1/2	33	140	
VS-15	8 1/4	79	11 5/8	12 5/8	10 1/8	13 1/4	10 9/16	16 1/2	7 1/2	11 11/16	3/4	1/2	2	6	1/2	85	0	1 7/8	1 1/4	C6 x 10.5	2 1/8	36	237	
VS-16	9 11/16	98	12 5/8	13 5/8	11 1/8	13 1/4	10 9/16	16 1/2	7 1/2	11 11/16	3/4	5/8	2	6	1/2	97	- 1/8	2 1/8	1 1/4	C8 x 11.5	2 1/8	36	292	
VS-17	10 7/8	122	13 7/8	14 7/8	12 3/8	13 1/4	10 9/16	16 1/2	7 1/2	11 11/16	3/4	5/8	2	6	1/2	126	- 1/4	2 3/8	1 1/4	C8 x 11.5	2 1/8	36	354	
VS-18	11 3/16	243	14 7/8	15 7/8	13 1/16	17 1/4	15 3/4	22	11 1/8	15 9/16	3/4	3/4	2 1/2	8	1/2	258	- 3/8	2 5/8	1 1/4	C12 x 20.7	2 3/8	42	673	
VS-19	12 3/16	291	15 11/16	16 11/16	13 13/16	17 1/4	15 3/4	22	11 1/8	15 9/16	3/4	3/4	2 1/2	8	1/2	291	- 1/2	2 13/16	1 1/4	C12 x 20.7	2 5/8	42	774	
VS-20	13	331	17 13/16	18 13/16	14 3/4	17 1/4	15 3/4	22	11 1/8	15 9/16	3/4	3/4	2 1/2	8	1/2	331	1/16	3 1/16	1 1/4	C12 x 20.7	2 7/8	40	863	
VS-21	15 1/8	415	19 3/4	20 3/4	17	17 1/4	16 7/8	22	11 15/16	15 9/16	3/4	1	3	8	1/2	417	- 3/4	3 5/16	1 1/4	C15 x 33.9	3 1/8	48	1173	
VS-22	17 5/8	517	24	25	19 7/8	17 1/4	16 7/8	22	11 15/16	15 9/16	3/4	1 1/4	3	8	1/2	522	- 7/8	3 9/16	1 1/4	C15 x 33.9	3 3/8	48	1424	

VARIABLE SUPPORTS - RANGE VS

ALL TYPES						SUSPENDED TYPES															VARIABLE SUPPORTS - RANGE VM			TYPE D			
Size	Rod Dia.	Body Dimensions				RTO			Minimum Thread Engagement AA	Depth of Thread A	AB (Min.)	AB (Max.)	Lug Dimensions Types B & C					Approx. Weights			Height J (at Zero Spring Def'n)	Allowance for Nuts AC	Approx. Weight				
		D	K	M	Casing Length L (not Type F)	TYPE A	TYPE B	TYPE C					E	F	G	H	T	TYPE A	TYPE B	TYPE C							
	in	in	in	in	in	in	in	in	in	in	in	in	in	in	in	in	in	in	in	in	in	in	in	in	in	in	in
VM-XXX	1/2	4 1/4	4 3/4	6 1/8	7 7/8	6 5/8	8 1/2	8 1/2	1 1/8	3/8	1/4	3 3/4	7/8	1 1/4	1 1/2	11/16	1/4	10	10	10	10	7/8	1 1/4	9			
VM-XX	1/2	4 1/4	4 3/4	6 1/8	7 7/8	6 5/8	8 1/2	8 1/2	1 1/8	3/8	1/4	3 3/4	7/8	1 1/4	1 1/2	11/16	1/4	10	10	10	10	7/8	1 1/4	9			
VM-X	1/2	4 1/4	4 3/4	6 1/8	7 7/8	6 5/8	8 1/2	8 1/2	1 1/8	3/8	1/4	3 3/4	7/8	1 1/4	1 1/2	11/16	1/4	10	10	10	10	7/8	1 1/4	9			
VM-0	1/2	4 1/4	4 3/4	6 1/8	7 7/8	6 5/8	8 1/2	8 1/2	1 1/8	3/8	1/4	3 3/4	7/8	1 1/4	1 1/2	11/16	1/4	10	10	10	10	7/8	1 1/4	9			
VM-1	1/2	4 1/4	4 3/4	6 1/8	8 1/2	7 1/4	9 1/8	9 1/8	1 1/8	3/8	1/4	3 3/4	7/8	1 1/4	1 1/2	11/16	1/4	11	11	11	11	1 1/2	1 1/4	9			
VM-2	1/2	4 1/4	4 3/4	6 1/8	8 9/16	7 3/4	9 5/8	9 5/8	1 1/8	3/8	11/16	4 3/16	7/8	1 1/4	1 1/2	11/16	1/4	10	11	11	11	9/16	1 1/4	9			
VM-3	1/2	5 3/4	6 1/2	7 7/8	8 3/4	7 3/8	9 3/8	9 3/8	1 1/8	1/2	1/4	3 3/4	7/8	1 1/4	1 1/2	11/16	1/4	20	20	20	20	3/4	1 1/4	19			
VM-4	1/2	5 3/4	6 1/2	7 7/8	8 7/8	7 5/8	9 5/8	9 5/8	1 1/8	1/2	3/8	3 7/8	7/8	1 1/4	1 1/2	11/16	1/4	20	21	21	21	7/8	1 1/4	19			
VM-5	1/2	5 3/4	6 1/2	7 7/8	8 15/16	7 5/8	9 5/8	9 5/8	1 1/8	1/2	5/16	3 13/16	7/8	1 1/4	1 1/2	11/16	1/4	21	21	21	21	15/16	1 1/4	19			
VM-6	5/8	5 3/4	6 1/2	7 7/8	9 1/4	7 13/16	9 13/16	9 13/16	1 1/4	1/2	5/16	3 13/16	1 1/16	1 1/4	1 1/2	13/16	1/4	21	22	22	22	1/4	1 1/2	20			
VM-7	5/8	5 3/4	6 1/2	7 7/8	9 7/8	8 15/16	10 15/16	10 15/16	1 1/4	1/2	13/16	4 5/16	1 1/16	1 1/4	1 1/2	13/16	1/4	23	23	23	23	7/8	1 1/2	21			
VM-8	5/8	5 3/4	6 1/2	7 7/8	10 15/16	9 1/2	11 1/2	11 1/2	1 1/4	1/2	5/16	3 13/16	1 1/16	1 1/4	1 1/2	13/16	1/4	26	26	26	26	15/16	1 1/2	24			
VM-9	3/4	6 7/8	7 3/4	9 7/8	10 7/16	9 1/16	11 3/16	11 3/16	1 3/8	5/8	5/8	4 1/8	1 1/4	1 1/4	1 1/2	15/16	3/8	37	38	39	39	7/16	1 3/4	34			
VM-10	3/4	6 7/8	7 3/4	9 7/8	11 5/16	11 1/2	13 5/8	13 5/8	1 3/8	5/8	2 3/16	5 11/16	1 1/4	1 1/4	1 1/2	15/16	3/8	39	40	41	41	5/16	1 3/4	36			
VM-11	3/4	6 7/8	7 3/4	9 7/8	12 1/8	10 1/2	12 5/8	12 5/8	1 3/8	5/8	3/8	3 7/8	1 1/4	1 1/4	1 1/2	15/16	3/8	43	44	44	44	1/8	1 3/4	39			
VM-12	1	8 3/4	9 7/8	12 5/8	12 3/16	10 13/32	13 1/16	13 1/16	1 5/8	1	1/2	4	1 5/8	1 1/2	2	1 1/4	1/2	71	72	74	74	3/16	2 1/4	63			
VM-13	1	8 3/4	9 7/8	12 5/8	13 1/16	11 15/32	14 1/8	14 1/8	1 5/8	1	11/16	4 3/16	1 5/8	1 1/2	2	1 1/4	1/2	79	81	83	83	1/16	2 1/4	70			
VM-14	1 1/4	8 3/4	9 7/8	12 5/8	14 5/16	12 5/32	16 1/16	16 1/16	1 7/8	1 1/4	5/8	4 1/8	2	2	3	1 1/2	5/8	95	98	102	102	5/16	3	80			
VM-15	1 1/4	8 3/4	9 7/8	13	16 5/16	14 5/32	18 1/16	18 1/16	1 7/8	1 1/4	5/8	4 1/8	2	2	3	1 1/2	5/8	116	118	122	122	5/16	3	100			
VM-16	1 1/2	8 3/4	9 7/8	13	18 5/8	16 3/32	20 1/4	20 1/4	2 1/8	1 1/2	3/4	4 1/4	2 3/8	2 1/2	3	1 3/4	3/4	149	153	158	158	5/8	3 1/2	129			
VM-17	1 3/4	8 3/4	9 7/8	13	21 1/8	18 1/8	22 5/8	22 5/8	2 3/8	1 3/4	7/8	4 3/8	2 5/8	2 1/2	3	2	3/4	188	196	204	204	1/8	4	160			
VM-18	2	13 1/8	14 3/4	19 5/8	18 7/8	16 5/8	21 7/8	21 7/8	2 5/8	2	1 5/8	5 1/8	2 7/8	3	4	2 3/8	3/4	346	356	369	369	7/8	4 9/16	306			
VM-19	2 1/4	13 1/8	14 3/4	19 5/8	21 1/2	19	24 3/4	24 3/4	2 13/16	2 3/16	1 9/16	5 1/16	3 1/8	3	4 1/2	2 5/8	3/4	404	417	431	431	1/2	5	357			
VM-20	2 1/2	13 1/8	14 3/4	20 1/2	24 1/2	22	28	28	3 1/16	2 7/16	2 1/16	5 9/16	3 3/8	4	4 1/2	2 7/8	1	490	509	534	534	1/2	5 9/16	430			
VM-21	2 3/4	13 1/8	14 3/4	20 7/8	29 1/16	25 9/16	31 9/16	31 9/16	3 5/16	2 11/16	1 5/16	4 13/16	3 5/8	4	4 1/2	3 1/8	1	635	653	676	676	1/16	6 1/4	551			
VM-22	3	13 1/8	14 3/4	21 1/4	33 7/16	30 3/4	37 1/2	37 1/2	3 9/16	2 15/16	2 5/8	6 1/8	3 7/8	4	5	3 3/8	1	800	823	852	852	7/16	6 5/8	681			

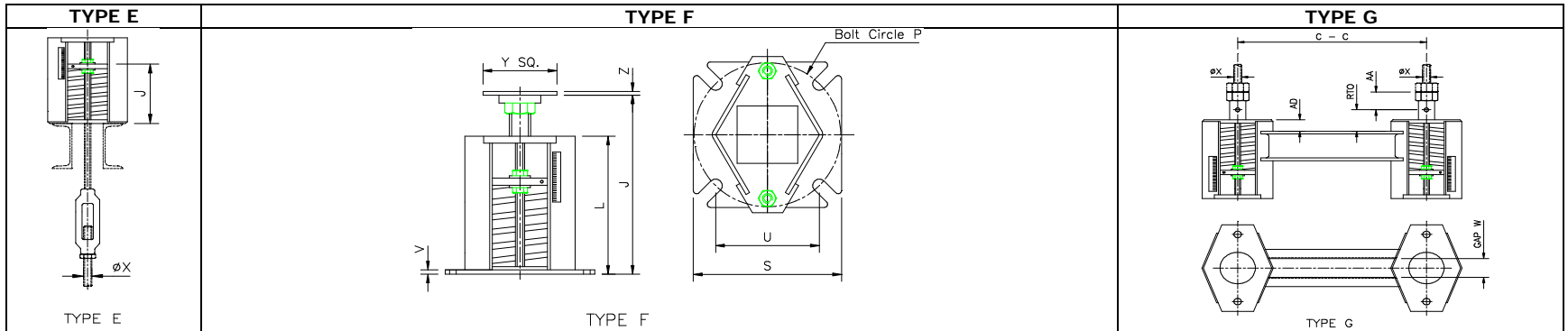

Size	Height J (at Zero Spring Def'n)	Approx. Weight	Min. Height J	Max. Height J	Casing Length L	Bottom Flange Square S	Bottom Flange Bolt Circle P (min.)	Bottom Flange Bolt Circle P (max.)	Bottom Flange Bolt Centers Square U (min.)	Bottom Flange Bolt Centers Square U (max.)	Bottom Flange Bolt Size	Bottom Flange Thick V	Load Column Thread Size	Load Flange Square Y	Load Flange Thick Z	Approx. Weight	RTO	Min. Thread Engage- ment AA	AD	Channel Size	Gap Between Channels W	Max. Rod Centers C-C	Approx. Weight (at Max. Rod Centers)
	in	lbs	in	in	in	in	in	in	in	in	in	in	in	in	in	lbs	in	in	in	in	in	in	lbs
VM-XXX	5 7/8	9	7 7/8	9 1/4	7 3/8	7 1/2	7	8 3/4	4 15/16	6 3/16	5/8	1/4	3/4	3	3/16	9	3/8	1 1/8	1 1/4	C3 x 4.1	5/8	24	34
VM-XX	5 7/8	9	7 7/8	9 1/4	7 3/8	7 1/2	7	8 3/4	4 15/16	6 3/16	5/8	1/4	3/4	3	3/16	9	3/8	1 1/8	1 1/4	C3 x 4.1	5/8	24	34
VM-X	5 7/8	9	7 7/8	9 1/4	7 3/8	7 1/2	7	8 3/4	4 15/16	6 3/16	5/8	1/4	3/4	3	3/16	9	3/8	1 1/8	1 1/4	C3 x 4.1	5/8	24	34
VM-0	5 7/8	9	7 7/8	9 1/4	7 3/8	7 1/2	7	8 3/4	4 15/16	6 3/16	5/8	1/4	3/4	3	3/16	9	3/8	1 1/8	1 1/4	C3 x 4.1	5/8	24	34
VM-1	6 9/16	9	8 3/4	10 1/4	8	7 1/2	7	8 3/4	4 15/16	6 3/16	5/8	1/4	3/4	3	3/16	9	3/8	1 1/8	1 1/4	C3 x 4.1	5/8	24	35
VM-2	6 5/8	9	9 1/2	11	8 1/16	7 1/2	7	8 3/4	4 15/16	6 3/16	5/8	1/4	3/4	3	3/16	9	13/16	1 1/8	1 1/4	C3 x 4.1	5/8	24	34
VM-3	6 1/2	18	9 3/16	10 11/16	8 1/4	7 1/2	7 3/4	8 3/4	5 1/2	6 3/16	3/4	5/16	1	3	3/16	21	3/8	1 1/8	1 1/4	C3 x 4.1	3/4	30	56
VM-4	6 9/16	18	9 3/16	10 11/16	8 3/8	7 1/2	7 3/4	8 3/4	5 1/2	6 3/16	3/4	5/16	1	3	3/16	21	1/2	1 1/8	1 1/4	C3 x 4.1	3/4	30	57
VM-5	6 11/16	19	9 7/8	11 3/8	8 7/16	7 1/2	7 3/4	8 3/4	5 1/2	6 3/16	3/4	5/16	1	3	3/16	22	7/16	1 1/8	1 1/4	C3 x 4.1	3/4	30	58
VM-6	7	19	10 1/8	12 1/8	8 13/16	9	8	10 7/8	5 11/16	7 11/16	3/4	3/8	1 1/4	3	1/4	24	5/16	1 1/4	1 1/4	C3 x 4.1	1	36	63
VM-7	7 9/16	21	11 5/16	13 5/16	9 7/16	9	8	10 7/8	5 11/16	7 11/16	3/4	3/8	1 1/4	3	1/4	25	13/16	1 1/4	1 1/4	C3 x 4.1	1	36	66
VM-8	8 11/16	24	11 3/8	13 3/8	10 1/2	9	8	10 7/8	5 11/16	7 11/16	3/4	3/8	1 1/4	3	1/4	27	5/16	1 1/4	1 1/4	C3 x 4.1	1	36	72
VM-9	7 3/4	32	11 3/4	13 3/4	9 13/16	13 1/4	10 9/16	16 1/2	7 1/2	11 11/16	3/4	1/2	1 1/2	4	1/2	44	1/2	1 3/8	1 1/4	C4 x 5.4	1 1/4	36	100
VM-10	8 5/8	35	13 7/16	15 7/16	10 11/16	13 1/4	10 9/16	16 1/2	7 1/2	11 11/16	3/4	1/2	1 1/2	4	1/2	46	2 1/16	1 3/8	1 1/4	C4 x 5.4	1 1/4	36	105
VM-11	9 7/16	38	12 5/8	14 5/8	11 1/2	13 1/4	10 9/16	16 1/2	7 1/2	11 11/16	3/4	1/2	1 1/2	4	1/2	49	1/4	1 3/8	1 1/4	C4 x 5.4	1 1/4	36	112
VM-12	9 1/4	61	12 5/8	14 5/8	11 3/8	13 1/4	10 9/16	16 1/2	7 1/2	11 11/16	3/4	1/2	1 3/4	5	1/2	70	1/8	1 5/8	1 1/4	C5 x 6.7	1 1/2	36	173
VM-13	10 1/8	68	14 7/16	16 7/16	12 1/4	13 1/4	10 9/16	16 1/2	7 1/2	11 11/16	3/4	1/2	1 3/4	5	1/2	75	5/16	1 5/8	1 1/4	C5 x 6.7	1 1/2	36	188
VM-14	11 1/8	79	14 1/2	16 1/2	13 1/4	13 1/4	10 9/16	16 1/2	7 1/2	11 11/16	3/4	1/2	1 3/4	5	1/2	83	0	1 7/8	1 1/4	C5 x 6.7	1 1/2	33	218
VM-15	12 11/16	98	16 1/2	18 1/2	15	13 1/4	10 9/16	16 1/2	7 1/2	11 11/16	3/4	1/2	2	6	1/2	103	0	1 7/8	1 1/4	C6 x 10.5	2 1/8	36	279
VM-16	14 7/8	125	18 1/4	20 1/4	16 3/4	13 1/4	10 9/16	16 1/2	7 1/2	11 11/16	3/4	5/8	2	6	1/2	122	- 1/8	2 1/8	1 1/4	C8 x 11.5	2 1/8	36	350
VM-17	17 1/16	156	20 1/2	22 1/2	19	13 1/4	10 9/16	16 1/2	7 1/2	11 11/16	3/4	5/8	2	6	1/2	157	- 1/4	2 3/8	1 1/4	C8 x 11.5	2 1/8	36	429
VM-18	14 13/16	299	19 15/16	21 15/16	17 3/16	17 1/4	15 3/4	22	11 1/8	15 9/16	3/4	3/4	2 1/2	8	1/2	311	1/4	2 5/8	1 1/4	C12 x 20.7	2 3/8	42	791
VM-19	17 1/2	352	22 3/16	24 3/16	19 9/16	17 1/4	15 3/4	22	11 1/8	15 9/16	3/4	3/4	2 1/2	8	1/2	348	0	2 13/16	1 1/4	C12 x 20.7	2 5/8	42	908
VM-20	20	427	25 7/16	27 7/16	22 3/16	17 1/4	15 3/4	22	11 1/8	15 9/16	3/4	3/4	2 1/2	8	1/2	423	1/4	3 1/16	1 1/4	C12 x 20.7	2 7/8	40	1073
VM-21	24 1/4	549	29 1/16	31 1/16	26 9/16	17 1/4	16 7/8	22	11 15/16	15 9/16	3/4	1	3	8	1/2	547	- 3/4	3 5/16	1 1/4	C15 x 33.9	3 1/8	48	1466
VM-22	28 1/8	687	35 1/8	37 1/8	30 13/16	17 1/4	16 7/8	22	11 15/16	15 9/16	3/4	1 1/4	3	8	1/2	688	5/16	3 9/16	1 1/4	C15 x 33.9	3 3/8	48	1797

VARIABLE SUPPORTS - RANGE VM

ALL TYPES						SUSPENDED TYPES															VARIABLE SUPPORTS - RANGE VL					
ALL TYPES						SUSPENDED TYPES															TYPE D					
Size	Rod Dia.	Body Dimensions				RTO			Minimum Thread Engagement AA	Depth of Thread A	AB (Min.)	AB (Max.)	Lug Dimensions Types B & C					Approx. Weights			Height J (at Zero Spring Def'n)	Allowance for Nuts AC	Approx. Weight			
		D	K	M	Casing Length L (not Type F)	TYPE A	TYPE B	TYPE C					E	F	G	H	T	TYPE A	TYPE B	TYPE C						
	in	in	in	in	in	in	in	in	in	in	in	in	in	in	in	in	in	in	lbs	lbs	lbs	in	in	lbs		
VL-XXX	1/2	4 1/4	4 3/4	6 1/8	13 13/16	12 9/16	14 7/16	14 7/16	1 1/8	3/8	1/4	7 1/4	7/8	1 1/4	1 1/2	11/16	1/4	13	13	13	19 13/16	1 1/4	12			
VL-XX	1/2	4 1/4	4 3/4	6 1/8	13 13/16	12 9/16	14 7/16	14 7/16	1 1/8	3/8	1/4	7 1/4	7/8	1 1/4	1 1/2	11/16	1/4	13	13	13	19 13/16	1 1/4	12			
VL-X	1/2	4 1/4	4 3/4	6 1/8	13 13/16	12 9/16	14 7/16	14 7/16	1 1/8	3/8	1/4	7 1/4	7/8	1 1/4	1 1/2	11/16	1/4	13	13	13	19 13/16	1 1/4	12			
VL-0	1/2	4 1/4	4 3/4	6 1/8	13 13/16	12 9/16	14 7/16	14 7/16	1 1/8	3/8	1/4	7 1/4	7/8	1 1/4	1 1/2	11/16	1/4	13	13	13	19 13/16	1 1/4	12			
VL-1	1/2	4 1/4	4 3/4	6 1/8	14 11/16	13 3/4	15 5/8	15 5/8	1 1/8	3/8	9/16	7 9/16	7/8	1 1/4	1 1/2	11/16	1/4	14	14	14	20 11/16	1 1/4	13			
VL-2	1/2	4 1/4	4 3/4	6 1/8	15 1/4	15	16 7/8	16 7/8	1 1/8	3/8	1 1/4	8 1/4	7/8	1 1/4	1 1/2	11/16	1/4	15	15	15	21 1/4	1 1/4	13			
VL-3	1/2	5 3/4	6 1/2	7 7/8	14 3/4	13 3/8	15 3/8	15 3/8	1 1/8	1/2	1/4	7 1/4	7/8	1 1/4	1 1/2	11/16	1/4	25	25	26	20 3/4	1 1/4	24			
VL-4	1/2	5 3/4	6 1/2	7 7/8	14 7/8	14 7/8	16 7/8	16 7/8	1 1/8	1/2	1 5/8	8 5/8	7/8	1 1/4	1 1/2	11/16	1/4	26	26	26	20 7/8	1 1/4	25			
VL-5	1/2	5 3/4	6 1/2	7 7/8	15 1/16	15 5/8	17 5/8	17 5/8	1 1/8	1/2	2 3/16	9 3/16	7/8	1 1/4	1 1/2	11/16	1/4	27	27	27	21 1/16	1 1/4	26			
VL-6	5/8	5 3/4	6 1/2	7 7/8	15 5/8	15 13/16	17 13/16	17 13/16	1 1/4	1/2	1 15/16	8 15/16	1 1/16	1 1/4	1 1/2	13/16	1/4	28	28	28	21 5/8	1 1/2	27			
VL-7	5/8	5 3/4	6 1/2	7 7/8	16 3/4	18 1/16	20 1/16	20 1/16	1 1/4	1/2	3 1/16	10 1/16	1 1/16	1 1/4	1 1/2	13/16	1/4	30	30	31	22 3/4	1 1/2	29			
VL-8	5/8	5 3/4	6 1/2	7 7/8	18 7/8	18 9/16	20 9/16	20 9/16	1 1/4	1/2	1 7/16	8 7/16	1 1/16	1 1/4	1 1/2	13/16	1/4	35	36	36	24 7/8	1 1/2	35			
VL-9	3/4	8 3/4	9 7/8	12 5/8	15 13/16	19	21 1/8	21 1/8	1 3/8	5/8	5 3/16	12 3/16	1 1/4	1 1/4	1 1/2	15/16	3/8	63	63	64	21 13/16	1 3/4	60			
VL-10	3/4	8 3/4	9 7/8	12 5/8	17 1/4	21 1/2	23 5/8	23 5/8	1 3/8	5/8	6 1/4	13 1/4	1 1/4	1 1/4	1 1/2	15/16	3/8	70	71	72	23 1/4	1 3/4	67			
VL-11	3/4	8 3/4	9 7/8	12 5/8	18 1/16	17	19 1/8	19 1/8	1 3/8	5/8	15/16	7 15/16	1 1/4	1 1/4	1 1/2	15/16	3/8	75	76	77	24 1/16	1 3/4	73			
VL-12	1	8 3/4	9 7/8	12 5/8	19 13/16	18 1/32	20 11/16	20 11/16	1 5/8	1	1/2	7 1/2	1 5/8	1 1/2	2	1 1/4	1/2	92	93	94	25 13/16	2 1/4	84			
VL-13	1	8 3/4	9 7/8	12 5/8	21 1/2	23 11/32	26	26	1 5/8	1	4 1/8	11 1/8	1 5/8	1 1/2	2	1 1/4	1/2	105	107	109	27 1/2	2 1/4	97			
VL-14	1 1/4	8 3/4	9 7/8	12 5/8	23 5/8	22 31/32	26 7/8	26 7/8	1 7/8	1 1/4	2 1/8	9 1/8	2	2	3	1 1/2	5/8	129	132	135	29 5/8	3	114			
VL-15	1 1/4	8 3/4	9 7/8	13	26 3/4	24 19/32	28 1/2	28 1/2	1 7/8	1 1/4	5/8	7 5/8	2	2	3	1 1/2	5/8	159	162	166	32 3/4	3	145			
VL-16	1 1/2	8 3/4	9 7/8	13	30 7/8	28 17/32	32 11/16	32 11/16	2 1/8	1 1/2	15/16	7 15/16	2 3/8	2 1/2	3	1 3/4	3/4	212	216	220	36 7/8	3 1/2	192			
VL-17	1 3/4	8 3/4	9 7/8	13	35 7/16	32 7/16	36 15/16	36 15/16	2 3/8	1 3/4	7/8	7 7/8	2 5/8	2 1/2	3	2	3/4	285	293	302	41 7/16	4	258			
VL-18	2	13 1/8	14 3/4	19 5/8	30 1/4	31 3/4	37	37	2 5/8	2	5 3/8	12 3/8	2 7/8	3	4	2 3/8	3/4	492	503	515	36 1/4	4 9/16	456			
VL-19	2 1/4	13 1/8	14 3/4	19 5/8	35 1/16	36 1/8	41 7/8	41 7/8	2 13/16	2 3/16	5 1/8	12 1/8	3 1/8	3	4 1/2	2 5/8	3/4	593	605	622	41 1/16	5	547			
VL-20	2 1/2	13 1/8	14 3/4	20 1/2	40 5/16	42 1/2	48 1/2	48 1/2	3 1/16	2 7/16	6 3/4	13 3/4	3 3/8	4	4 1/2	2 7/8	1	750	769	794	46 5/16	5 9/16	686			
VL-21	2 3/4	13 1/8	14 3/4	20 7/8	48 3/8	46 7/16	52 7/16	52 7/16	3 5/16	2 11/16	2 7/8	9 7/8	3 5/8	4	4 1/2	3 1/8	1	993	1012	1035	54 3/8	6 1/4	899			
VL-22	3	13 1/8	14 3/4	21 1/4	56 3/8	59 1/8	65 7/8	65 7/8	3 9/16	2 15/16	8 1/16	15 1/16	3 7/8	4	5	3 3/8	1	1275	1299	1330	62 3/8	6 5/8	1140			

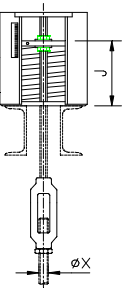
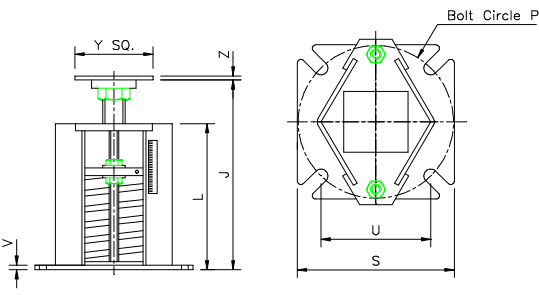
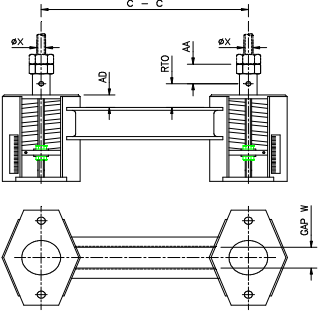
TYPE E			TYPE F														TYPE G						
																							
Size	Height J (at Zero Spring Defl'n)	Approx. Weight	Minimum Height J	Maximum Height J	Casing Length L	Bottom Flange Square S	Bottom Flange Bolt Circle P (min.)	Bottom Flange Bolt Circle P (max.)	Bottom Flange Bolt Centers Square U (min.)	Bottom Flange Bolt Centers Square U (max.)	Bottom Flange Bolt Size	Bottom Flange Thick V	Load Column Thread Size	Load Flange Square Y	Load Flange Thick Z	Approx. Weight	RTO	Minimum Thread Engagement AA	AD	Channel Size	Gap Between Channels W	Maximu m Rod Centers C-C	Approx. Weight (at Max. Rod Centers)
	in	lbs	in	in	in	in	in	in	in	in	in	in	in	in	in	lbs	in	in	in		in	in	lbs
VL-XXX	11	12	13 13/16	15 13/16	13 5/16	7 1/2	7	8 3/4	4 15/16	6 3/16	5/8	1/4	3/4	3	3/16	10	3/8	1 1/8	1 1/4	C3 x 4.1	5/8	24	39
VL-XX	11	12	13 13/16	15 13/16	13 5/16	7 1/2	7	8 3/4	4 15/16	6 3/16	5/8	1/4	3/4	3	3/16	10	3/8	1 1/8	1 1/4	C3 x 4.1	5/8	24	39
VL-X	11	12	13 13/16	15 13/16	13 5/16	7 1/2	7	8 3/4	4 15/16	6 3/16	5/8	1/4	3/4	3	3/16	10	3/8	1 1/8	1 1/4	C3 x 4.1	5/8	24	39
VL-0	10 15/16	12	13 13/16	15 13/16	13 5/16	7 1/2	7	8 3/4	4 15/16	6 3/16	5/8	1/4	3/4	3	3/16	10	3/8	1 1/8	1 1/4	C3 x 4.1	5/8	24	39
VL-1	11 13/16	12	15 9/16	17 9/16	14 3/16	7 1/2	7	8 3/4	4 15/16	6 3/16	5/8	1/4	3/4	3	3/16	11	11/16	1 1/8	1 1/4	C3 x 4.1	5/8	24	41
VL-2	12 3/8	13	17 1/16	19 1/16	14 3/4	7 1/2	7	8 3/4	4 15/16	6 3/16	5/8	1/4	3/4	3	3/16	11	1 3/8	1 1/8	1 1/4	C3 x 4.1	5/8	24	43
VL-3	11 5/8	23	15 1/4	17 1/4	14 1/4	7 1/2	7 3/4	8 3/4	5 1/2	6 3/16	3/4	5/16	1	3	3/16	24	3/8	1 1/8	1 1/4	C3 x 4.1	3/4	30	67
VL-4	11 3/4	24	16 1/2	18 1/2	14 3/8	7 1/2	7 3/4	8 3/4	5 1/2	6 3/16	3/4	5/16	1	3	3/16	25	1 3/4	1 1/8	1 1/4	C3 x 4.1	3/4	30	68
VL-5	11 7/8	25	17 7/8	19 7/8	14 9/16	7 1/2	7 3/4	8 3/4	5 1/2	6 3/16	3/4	5/16	1	3	3/16	25	2 5/16	1 1/8	1 1/4	C3 x 4.1	3/4	30	70
VL-6	12 7/16	26	18	20	15 3/16	9	8	10 7/8	5 11/16	7 11/16	3/4	3/8	1 1/4	3	1/4	28	1 15/16	1 1/4	1 1/4	C3 x 4.1	1	36	76
VL-7	13 9/16	28	19 15/16	21 15/16	16 5/16	9	8	10 7/8	5 11/16	7 11/16	3/4	3/8	1 1/4	3	1/4	30	3 1/16	1 1/4	1 1/4	C3 x 4.1	1	36	81
VL-8	15 11/16	33	20 7/8	22 7/8	18 7/16	9	8	10 7/8	5 11/16	7 11/16	3/4	3/8	1 1/4	3	1/4	34	1 7/16	1 1/4	1 1/4	C3 x 4.1	1	36	91
VL-9	12 5/16	57	21 1/2	23 1/2	15 5/16	13 1/4	10 9/16	16 1/2	7 1/2	11 11/16	3/4	1/2	1 1/2	4	1/2	63	5 1/16	1 3/8	1 1/4	C4 x 5.4	1 1/4	36	150
VL-10	13 3/4	64	23 15/16	25 15/16	16 3/4	13 1/4	10 9/16	16 1/2	7 1/2	11 11/16	3/4	1/2	1 1/2	4	1/2	69	6 1/8	1 3/8	1 1/4	C4 x 5.4	1 1/4	36	165
VL-11	14 9/16	69	19 9/16	21 9/16	17 9/16	13 1/4	10 9/16	16 1/2	7 1/2	11 11/16	3/4	1/2	1 1/2	4	1/2	74	13/16	1 3/8	1 1/4	C4 x 5.4	1 1/4	36	175
VL-12	16	80	20 13/16	22 13/16	19	13 1/4	10 9/16	16 1/2	7 1/2	11 11/16	3/4	1/2	1 3/4	5	1/2	87	1/8	1 5/8	1 1/4	C5 x 6.7	1 1/2	36	214
VL-13	17 5/8	93	26 1/16	28 1/16	20 11/16	13 1/4	10 9/16	16 1/2	7 1/2	11 11/16	3/4	1/2	1 3/4	5	1/2	97	3 3/4	1 5/8	1 1/4	C5 x 6.7	1 1/2	36	240
VL-14	19 9/16	110	26 3/16	28 3/16	22 9/16	13 1/4	10 9/16	16 1/2	7 1/2	11 11/16	3/4	1/2	1 3/4	5	1/2	112	1 1/2	1 7/8	1 1/4	C5 x 6.7	1 1/2	33	285
VL-15	22 5/16	140	27 3/8	29 3/8	25 7/16	13 1/4	10 9/16	16 1/2	7 1/2	11 11/16	3/4	1/2	2 1/2	6	1/2	140	0	1 7/8	1 1/4	C6 x 10.5	2 1/8	36	366
VL-16	26 1/4	183	31 1/2	33 1/2	29	13 1/4	10 9/16	16 1/2	7 1/2	11 11/16	3/4	5/8	2 1/2	6	1/2	175	1/16	2 1/8	1 1/4	C8 x 11.5	2 1/8	36	475
VL-17	30 9/16	245	35 5/8	37 5/8	33 5/16	13 1/4	10 9/16	16 1/2	7 1/2	11 11/16	3/4	5/8	2 1/2	6	1/2	240	- 1/4	2 3/8	1 1/4	C8 x 11.5	2 1/8	36	622
VL-18	25 5/16	438	34 15/16	36 15/16	28 9/16	17 1/4	15 3/4	22	11 1/8	15 9/16	3/4	3/4	3	8	1/2	441	4	2 5/8	1 1/4	C12 x 20.7	2 3/8	42	1084
VL-19	30 3/16	526	39 7/16	41 7/16	33 1/8	17 1/4	15 3/4	22	11 1/8	15 9/16	3/4	3/4	3	8	1/2	511	3 9/16	2 13/16	1 1/4	C12 x 20.7	2 5/8	42	1285
VL-20	34 7/8	666	45 15/16	47 15/16	38	17 1/4	15 3/4	22	11 1/8	15 9/16	3/4	3/4	3	8	1/2	650	4 15/16	3 1/16	1 1/4	C12 x 20.7	2 7/8	40	1592
VL-21	42 5/8	873	51 1/2	53 1/2	45 7/8	17 1/4	16 7/8	22	11 15/16	15 9/16	3/4	1	3 1/2	8	1/2	860	13/16	3 5/16	1 1/4	C15 x 33.9	3 1/8	48	2183
VL-22	50 1/8	1114	63 5/8	65 5/8	53 3/4	17 1/4	16 7/8	22	11 15/16	15 9/16	3/4	1 1/4	3 1/2	8	1/2	1105	5 3/4	3 9/16	1 1/4	C15 x 33.9	3 3/8	48	2748

VARIABLE SUPPORTS - RANGE VL

COMET' VARIABLE EFFORT SUPPORTS

ERECTION AND MAINTENANCE INSTRUCTIONS

1.0) INTRODUCTION

This manual gives guidance and recommendations for the erection, commissioning and subsequent maintenance of 'COMET' variable effort supports.

Unlike their more sophisticated relatives the constant effort support, variable effort supports are simple devices that allow a degree of flexibility in the supported equipment. They are in fact a spring balance that, for an increase in load, yield a corresponding change in compressed length in direct relation to the spring stiffness.

The criteria for selecting variable effort supports falls into three general categories, firstly the load and displacement for which the support has to cater, secondly the physical arrangement of the support, be it top hung or base mounted, and finally the allowable deviation in load that the pipe can sustain.

Load and displacement are inseparable from allowable deviation since the latter is a direct function of the design load. The thermal displacement and the spring stiffness is expressed as "the change in load due to thermal displacement with respect to the design load in the operating condition".

BS3974 sets down guidelines on the limit of deviation, though generally it is determined by the pipe work stress engineer, and can vary for individual support position. As a general rule it should not normally exceed 25%.

$$\text{Where: Deviation (\%)} = \frac{\text{displacement} \times \text{spring stiffness} \times 100}{\text{Operating load}}$$

It is essential that the support is erected in the correct position. Error at the erection stage can cause a re-distribution of the load and make it virtually impossible to 'balance' the supporting system.

When selecting the support at the design stage it is important that any additional load be added to the nominal design load of the supported plant. Large pipe clamps, spreader beams, the self weight of (G type) tandem supports or even long hanger rods can impose significant increases in dead weight.

2.0) ERECTION:

2.1 Variable effort supports rely on the freedom of movement of the spring and its compression plate. Lack of adequate protection during storage, rough handling and abuse will significantly reduce the ability of the support to perform.

2.2 The support should be carefully lifted into its nominated position and secured using appropriately sized fixing bolts.

2.3 Attachment to the supported pipe work is made via the hanger rod and pipe clamp in the case of suspension type supports and via the base in the case of compression type supports. The pipe work should be accurately adjusted to its correct elevation using either the turnbuckle or the height adjustment nut.

Due to the variable nature of these devices and the need to support the pipe work at its optimum load when operating, it is necessary to either over support or under support when installing a variable and in effect pre-stress the pipe work such that during thermal expansion it moves to a neutral state of stress. This is achieved by allowing moments at anchor and terminal points to cater for the variance while the pipe is in the 'cold' state and has greater elastic durability.

2.4 Once satisfied that the pipe work is at its correct elevation, the process of 'balancing' the system can commence. If the original assessment of weight distribution was correct, the pipe has been supplied to the nominal weight, valves and lagging are at their theoretical might and all the supports are in their correct position. Then it is simply a case of undoing the locking nuts and walking away! However, this is rarely the case.

2.5 The process of balancing the supporting system is very much an iterative one, adjustment to one support may manifest in a change at another two or three positions away. It is best to work between fixed support positions or terminal points and work towards the center where the piping is most flexible.

2.6 To determine whether a support is in balance or not, it is necessary to observe the piston plate locking nuts found on threaded rods running the full length of the spring canister with the piston plate sandwiched between each pair. For balance, these nuts should all be relatively free to be unwound away from the piston plate leaving the support in a static, self-supporting state. If this is the case for any particular support we strongly recommend that the nuts should be wound only 3/16" away from the plate at this stage. This is simply a precaution to avoid the pipe work moving far away from its set position if subsequent supports are not truly balanced.

2.7 If the support is not in balance, then either the lower (spring side) locking nut or the upper locking nut will offer significant resistance to turning. Should it be that the lower nut will not rotate then this signifies that the dead weight is greater than the effort being provided by the support. To compensate for this it is either necessary to lower the pipe slightly by releasing the turnbuckle or lowering the load pad, or by raising the pipe slightly on adjacent supports. The intention being to release the dead weight sufficiently to release the locking nuts. For base mounted supports the height adjustment nut is found immediately below the load base. Should the upper nut be difficult to rotate then the opposite should be applied.

We recommend that this adjustment should not be carried out in total isolation. At least five consecutive supports should be worked on simultaneously to avoid introducing local stresses into the pipe work.

2.8 Subsequent supports should be balanced in the same way. However, it is necessary to continually check back to center supports to ensure that the effect of changing supports towards the center of the pipe run does not alter previously balanced supports. If this is the case then suitable adjustments should be made to overcome this and return these supports back to their correct position.

2.9 When all supports are floating, the locking nuts should be backed off fully to allow the system to operate correctly.

2.10 Where the variable effort support incorporates a limit stop (Reaction force receiver), the lower locking nuts will be positioned at a distance from the spring compression plate as shown on the support detail drawing.

2.11 Prior to operating the plant we recommend that all supports are checked to ensure -

- The locking nuts are fully retracted.
- No debris has been allowed to fall into the support, especially in the spring housing.
- The support is free from visual damage and fixing bolts are firmly secured.

We also suggest that a cold survey is carried out to record the installed elevation of the pipe work and the indicated setting of the supports.

3.0 MAINTENANCE:

3.1 'COMET' variable effort supports are designed to be maintenance free. However, common sense should prevail. Threaded items require greasing at intervals to suit the environment. Periodic inspections are necessary to ensure the supports have not been damaged or obstructed by such items as temporary scaffolding, additional equipment or debris that may have fallen into the unit. Protective coatings should be periodically inspected and if necessary repaired.

3.2 Unfortunately, due to the wide-ranging environments these devices are employed in, it is impossible to compile a fully comprehensive maintenance procedure. It should be remembered that variable effort supports are mechanisms, and the health and longevity of the piping system depends on the reliable operation of the pipe supports.

4.0 STORAGE:

4.1 Supports should be handled with care and stored in a dry and dust free environment, preferably off the floor and under cover.